

REV.	DESCRIPTION	DATE	DRAWN
A	New	05.11.2014	Ryan
B	general update	25.05.2018	Chery

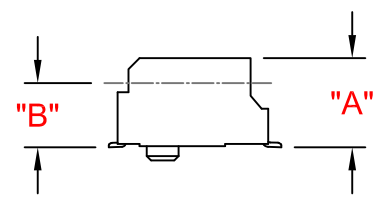

Order Code
MPE-075-RXE9-55/R

Dimension mm	Height	Option
"A"	"B"	E
3,05	1,50	E
4,05	2,50	L

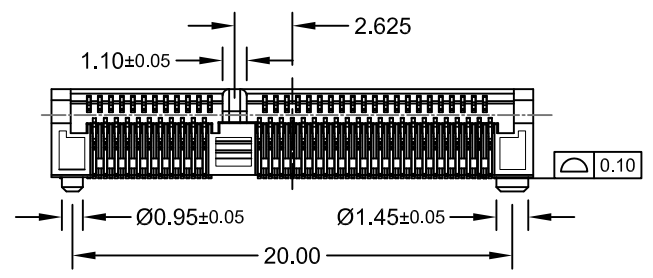
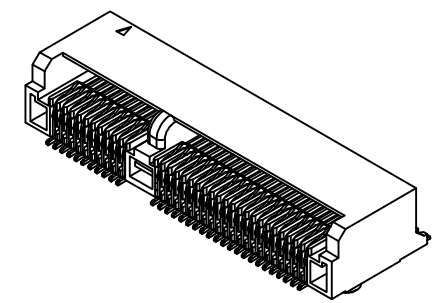
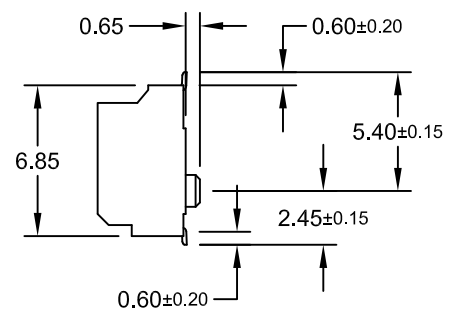
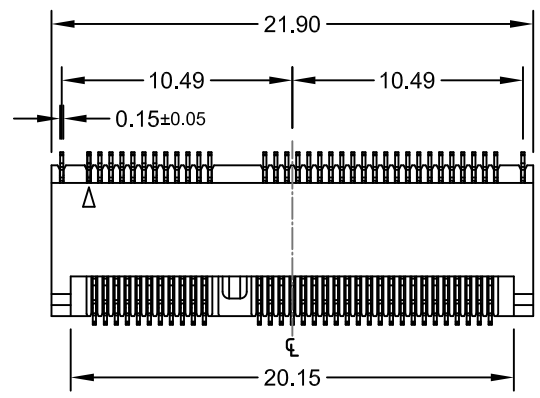
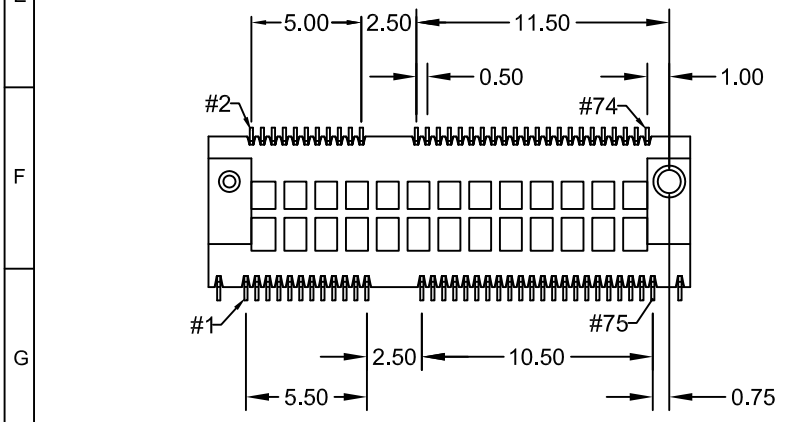

Specifications

Electrical
 Current rating: 0.5A / Contact
 Insulation resistance: 500MΩ min.
 Contact resistance: 55mΩ max.
 Voltage rating: 35V AC
 Withstanding voltage: 300V AC rms / Minute



Material

Contact: Copper Alloy
 Plating: Au flash over Ni
 Insulator: LCP (Black) UL 94V-0

Operating temperature: -40°C to +80°C
 Processing temperature: +255°C +0/-5°C for 10 seconds

Mechanical Requirements

Lifetime: 50 cycles min.

Packing: Reel (others on request)

For the PCB layout we refer to page 2/2

E-tec 2018 © - all rights reserved

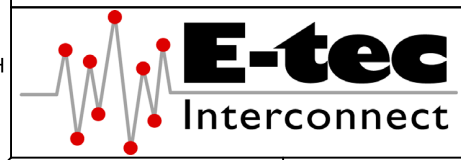

UNIT	mm	GENERAL TOLERANCE		DRAWN	DATE	DWG. NO.	SHEET 1/2
SCALE	Free	X.° ±	X. ±	Ryan	05.11.2014	MPE-075-RE9	REV. B
		.X° ±	.X ±	Hogi	13.06.2018	SERIES NO.	
		.XX° ±	.XX ± 0.10	Hogi	13.06.2018	MPE-075-RXE9-xx/R	
		.XXX° ±	.XXX ±				

Mini PCI Express Connector
 M.2 (NGFF) "E" Key
 0.50mm pitch - 75 Contact Type

